

Model 742A

Audio Mixer

User Guide

Issue 1, July 2012

This User Guide is applicable for serial numbers:
M742A-01151 and later

© 2012 by Studio Technologies, Inc., all rights reserved

www.studio-tech.com

This page intentionally left blank.

Table of Contents

Introduction	5
System Features	6
Configuration Review	9
Installation	10
Post-Installation Calibration	17
Operation	18
Technical Notes.....	24
Specifications.....	28
Block Diagram	

Model 742A

Audio Mixer

This page intentionally left blank.

Introduction

What This User Guide Covers

This User Guide is designed to assist you when installing, configuring, and using the Model 742A Audio Mixer. Additional background and technical information is also provided, as well as a product block diagram included at the end of this guide.

System Overview

The Model 742A Audio Mixer is expressly designed for use in electronic-news-gathering (ENG) vehicles and small production truck applications. Many other fixed and mobile audio production, on-air, and utility applications can also be supported. Model 742A features include four mic/line inputs with +48 volt phantom power, four line inputs, two output buses, LED level metering, flexible monitoring, and AC and DC powering. The Model 742A was specifically designed as a dual-channel audio mixer, rather than as a typical stereo device. This approach makes it excellent for “dual-path” on-air applications. As a utility

mixer the Model 742A can create two independent monaural signals, excellent for general signal monitoring, talent cueing, or intercom support uses.

The Model 742A is targeted for use by operators with numerous audio sources that need to be quickly and reliably adjusted and routed to create one or two independent audio mixes. In these days of operators having too many tasks to handle, and too little time to do them, the Model 742A is a refreshing combination of performance and simplicity. Using their experience in mobile broadcast applications, the engineers at Studio Technologies were able to design the Model 742A to include all the crucial features required to meet the needs of fast-paced news-gathering operations, while still providing the operator with an easy-to-use product.

The hallmarks of the Model 742A are application flexibility, simplicity in use, audio quality, and long-term reliability. For powering, the unit can be directly connected to an AC mains source. A true “universal input” design that’s intended

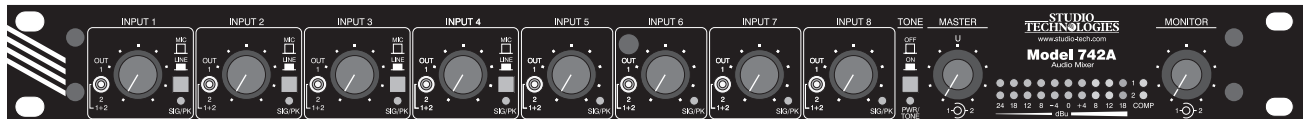

Figure 1. Model 742A Front Panel

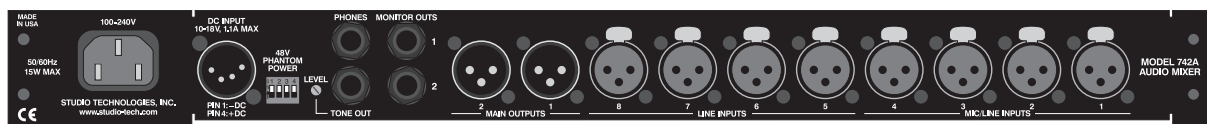

Figure 2. Model 742A Back Panel

for worldwide use, the input voltage can range from 100 to 240 volts, 50/60 Hz. A source of 10 to 18 volts DC can also be connected to power the Model 742A. If both AC and DC sources are connected, the AC source will power the unit while the DC source will serve as a backup. In this way a battery can be connected, ready to serve in a standby capacity.

A carefully selected feature set ensures that the Model 742A will be a “team player” when it is integrated into an audio system. A number of internal configuration “jumpers” allow the unit’s performance to be tailored to the needs of specific installations. And while there’s flexibility on the inside, the operator is presented with an easy-to-use set of front-panel controls and indicators—the operator typically never has to access the back panel to operate the unit. In this way the goal of delivering successful on-air and production audio, day-after-day, can best be achieved. The Model 742A’s audio quality is “pro” throughout. The components were carefully selected to deliver low-noise, low-distortion performance.

Long-term reliability was also part of the Model 742A’s design criteria. To that end the unit’s enclosure is made of lightweight yet rugged aluminum with a steel front panel for overall rigidity which adds to rack-mounting stability. On the inside, a conservative circuit design combines state-of-the-art integrated circuits for sonic quality with numerous filtering and protection components for long-term reliability.

System Features

Mic/Line Inputs

Four input channels are provided for connection to microphone or line-level signals. The electronically balanced circuitry is “ruggedized” for reliable operation under tough operating conditions. The low-noise, low-distortion, high-headroom audio performance is what’s expected of sophisticated “pro audio” equipment. Features provided for each input channel include an input sensitivity button, rotary level control, signal level status LED, and output bus assignment switch. To support condenser microphones, the four mic/line inputs can be individually configured to supply 48 volt phantom power. Four DIP switches, accessible on the back panel, allow individual channel phantom power on/off control.

For ease of use, each input’s rotary level control sets the gain of the input circuit as well as the level being sent to the selected main output bus (or buses). For convenience the input sensitivity button, as with the other Model 742A operator controls, is located on the front panel. For operator assistance, a dual-color level status LED provides signal present and peak level indication.

Associated with each mic/line input channel is a 3-position output bus assignment switch. This allows each input to be assigned to bus 1, bus 2, or both, quickly creating two fully independent audio “feeds.” Bus assignment switches, rather than the more-typical “pan pots,” were specifically selected for the Model 742A’s design. This allows a more positive assignment of an input source to the desired

output bus (or buses), minimizing the chance of unwanted “leakage.” Pan pots are fine in an audio mixer destined for use in stereo music situations, but are inferior when used for two-bus applications.

Line Inputs

Four input channels are provided for connection to line-level signals. Features provided for each line input channel include a rotary level control, level status LED, and output bus assignment switch. The rotary level control is used to set the amount of input signal that is sent to the selected main output bus (or buses). The dual-color level status LED provides signal present and peak level indication. A 3-position switch allows the input signal to be assigned to the desired output bus (or buses).

Main Output Buses

Signals from the eight input channels (four mic/line and four line) are routed and combined to create the two main output buses. A dual rotary control is used to independently set the overall level of the two buses. An electronically balanced output circuit is associated with each main output bus. They provide line-level signals capable of driving balanced or unbalanced loads of 600 ohms or greater. Separate studio-quality audio compressor circuits are provided to control the dynamic range of each main output bus. An LED indicator is associated with each compressor, lighting whenever the circuit is actively controlling signal level. Far from simple “clippers,” the compressor circuits utilize sophisticated laser-trimmed voltage-controlled amplifier (VCA) integrated circuits for quiet, low-distortion operation. To help minimize operator error no

compressor on/off switches are provided on the Model 742A’s front panel. Internal configuration jumpers determine the compressor circuits’ operating modes. From the factory the jumpers are set so that the compressors’ operating threshold is 6 dB above the nominal +4 dBu output level. This is an excellent general-purpose setting for broadcast use where voice signals are the primary audio content.

To meet the needs of other applications, a technician can change the jumpers to make the compressor threshold 2 dB above the nominal +4 dBu. This could prove useful when using the Model 742A with level-sensitive RF transmission systems. For other applications a technician can set the jumpers to a third position which completely disables the compressor functions.

Monitor Section

The Model 742A’s monitor section provides two line-level monitor outputs and a “stereo” headphone output. Monitor outputs 1 and 2 are electrically balanced with their input sources associated with output buses 1 and 2, respectively. The headphone output has main output bus 1 as its left-channel source and main output bus 2 as its right-channel source. Associated with the monitor section is a dual rotary level control that allows independent setting of the monitor output levels. The level of the headphone output is always adjusted using these controls. Internal configuration jumpers are used to select the exact signal sources for the line-level monitor outputs. They can either be “post” the controls, allowing an adjustable output level, or set to a fixed –10 or +4 dBu nominal level. This allows the monitor outputs

to be compatible with a variety of monitor amplifiers, amplified loudspeakers, or even to serve as an additional set of main bus line-level outputs.

From the factory the Model 742A's monitor outputs are configured to the "post" setting, enabling them to "follow" the setting of the front-panel level controls. This is appropriate where monitor loudspeakers and associated power amplifier channels are used. A technician can change the jumper positions so that the monitor outputs are electrically before ("pre") the level controls. Two jumper positions are available, corresponding to -10 and $+4$ dBu nominal output levels. The -10 position can be very useful when connecting the monitor outputs to amplified loudspeakers that contain user-accessible level controls. Examples of amplified speakers that contain user level controls include the popular Fostex® 6301-series. With the jumpers set to the -10 position, only one level control—the one in the amplified speaker—would be used to set that speaker's level. This can greatly minimize operator confusion and enhance performance.

When the unit is configured for $+4$ operation the monitor outputs are again "pre" the level controls, but this time with a nominal level of $+4$ dBu. This can be used for various applications, including providing an additional set of main bus outputs. In certain cases this may eliminate the need for an external distribution amplifier to be included as part of the installed system.

Metering

As previously discussed, individual dual-color signal present/peak LEDs are associated with the four mic/line input and the four line input channels. In addition,

two 10-segment LED meters provide an indication of audio-signal levels present on the main output buses. These meters use three LED colors: green, yellow, and red. The LEDs are calibrated such that the actual output level, in dBu, is indicated. Two additional LEDs, one for each output bus, display the status of the compressor circuits. They light whenever the compressors are actively controlling the dynamic range of the audio signals.

Reference Tone

A sine-wave audio tone is provided for alignment and reference use. From the factory the tone is configured for 400 Hz. If required, a technician can revise the frequency to be 1 kHz. A button on the Model 742A's front panel allows the tone to be connected to the main output buses. In addition, a dedicated reference tone output is also provided. This continuous source of sine-wave signal is accessed by means of a balanced line-level output on the back panel. The dedicated reference tone output is intended to provide a setup or test signal that is available at all times, without interfering with normal operation of the main output buses.

Mounting, Connectors, and Power

The Model 742A requires one space in a standard 19-inch rack. Industry-standard XLR and $\frac{1}{4}$ -inch 3-conductor connectors are used for all audio interconnections. To maximize reliability, all connectors were carefully selected from among premium-grade models. For example, the XLR connectors feature metal shells and are manufactured by Neutrik®. AC mains power can be connected directly to the Model 742A by way of a standard 3-pin

detachable IEC cord set; no external power supply is used. Having a “universal input,” the AC mains power source can range from 100 to 240 volts, 50/60 Hz, with no switches to set or straps to change. A source of 10 to 18 volts DC can also be connected to power the Model 742A. This allows the unit to operate from a variety of battery and external DC power supply sources. The power input circuitry was carefully designed to allow simultaneous connection of both AC mains and DC power sources. In this scenario the AC mains source will power the Model 742A while only an extremely small amount of current will be drawn from the DC source. Upon loss of AC mains power the DC source will, without interruption, begin to power the unit. Far from a simple diode “OR” circuit, this is a true “hot-swap” type design.

Configuration Review

In this section you will be reviewing the configuration of the Model 742A. Configuration changes will be made if required. Any changes should be made prior to installing the unit.

As previously mentioned in this guide, three Model 742A operating parameters can be configured to meet the exact needs of specific applications. These include compressor mode, monitor output mode, and reference tone frequency. While simple to perform, all changes do require the skill of an experienced and competent technician. This person must ensure that AC mains power is disconnected prior to removing the unit’s cover. Then the locations of the configuration jumpers can be

identified and changes made as required. In the case of revising the reference tone frequency, a calibration trim pot must also be adjusted.

Compressor Modes

The compressor circuits associated with the two output buses can be configured to operate from one of three modes:

- From the factory the compressors are set to have an operating threshold of 6 dB above the main outputs’ nominal +4 dBu operating level. In other words, the compressors will begin to function whenever the main output levels reach about +10 dBu, as measured on the output connectors. This is an excellent general-purpose setting that is appropriate for most applications.
- Alternately, the compressors’ threshold can be changed to be 2 dB above the nominal +4 dBu operating level. This may be appropriate for applications where an RF transmission chain places severe restrictions on the audio signal’s dynamic range.
- While not recommended for most applications, the compressors can also be configured to be disabled. With this configuration, no dynamic range control will take place. For most on-air applications this is probably not appropriate. Take advantage of the Model 742A’s highly effective dynamic range control to assist in providing clear, intelligible audio!

Monitor Output Modes

The line-level monitor outputs can be configured to operate from one of three modes:

- From the factory the monitor outputs are set to follow the position of the front-panel rotary level controls. This mode of operation is referred to as being “post” the level controls.
- An alternate configuration is specifically provided for use in applications where amplified loudspeakers with built-in user level controls are connected. This “pre” level-control mode provides fixed nominal output levels of -10 dBu. This prevents the confusing situation of having multiple level controls—the Model 742A’s and the amplified speakers’—both impacting the level of a speaker. In this case the Model 742A’s front-panel controls will only impact the headphone output.
- A third configuration provides a “pre” level-control mode with a fixed nominal output level of $+4$ dBu. This can be useful for applications where an additional set of main outputs is required. Except for using $\frac{1}{4}$ -inch 3-conductor jacks (versus XLRs) the monitor outputs are identical in quality as compared to the main outputs. Again in this mode the Model 742A’s front-panel controls will only impact the headphone output.

Reference Tone Frequency

From the factory the frequency of the reference tone is configured to be 400 Hz. This is a nice alternative to the more-typical 1 kHz, a frequency which can soon become very annoying to a listener’s ears. In most cases 400 Hz will be perfectly acceptable, and actually preferred. But in those

situations where 1 kHz is necessary, two configuration jumpers are provided to shift the frequency range so that the oscillator circuitry can be calibrated for 1 kHz.

Configuration Wrap-Up

If it is determined that any configuration changes are required, they should now be performed. For specific details on how to make configuration changes, refer to the Technical Notes section of this guide. The details provided should make the process simple and relatively painless.

It’s highly recommended that a Model 742A’s actual configuration be confirmed prior to installation. Even factory-fresh units can “mysteriously” end up having their default configurations changed prior to actual installation. The same “gremlin” that borrows and doesn’t return tools, drinks your favorite soda that you left in the tech-shop refrigerator, and pulls important patch cords has been known to sneak inside equipment and revise settings!

Installation

In this section you will be installing and interconnecting the Model 742A. The one-rack-space unit will be installed in an equipment rack. Audio input and output connections will be made using the 3-pin XLR connectors and $\frac{1}{4}$ -inch 3-conductor jacks. In most cases AC mains power will be connected by means of a detachable cord set that is compatible with the Model 742A’s 3-pin IEC 320 C14 inlet connector. Some applications may warrant connection of a source of 10 to 18 volts DC which can be made by way of a 4-pin XLR connector. The DC source can be used to power the Model 742A or it can serve as a backup source for a connected AC mains source.

System Components

The shipping carton contains a Model 742A Audio Mixer, user guide, and AC mains cord suitable for use in North America and Japan. When installed in other locations your dealer or distributor should provide a suitable AC mains cord.

Locating the Unit

Now that the Model 742A's configuration has been reviewed and, if required, revised, the unit can be mounted in an equipment rack. Physical access and viewing angles are the primary issues to be considered when choosing a mounting location. By its very nature as an audio mixer, an operator will need easy access to all the controls. A good sight line to the LED level meters, located on the right side of the front panel, is also important.

As a device that contains high-gain audio stages, hum and noise pickup is possible by way of the chassis and associated cabling. Locating the unit away from devices that radiate strong AC fields is an excellent idea.

During normal operation, access to the Model 742A's back panel is not typically required. However, as the +48 volt phantom power DIP switches are located on the back panel it's possible that access would be helpful. In most cases the phantom power switches can be set and kept in their desired on or off positions. By the very nature of phantom power, the presence of it on a microphone input shouldn't impact the performance of microphones that don't utilize phantom power. But there may be cases where their settings need to be changed.

Also accessible on the back panel is one trim potentiometer that may need to be adjusted prior to the Model 742A going into service. This trim pot sets the level of the reference tone direct output. Please refer to the Post-Installation Calibration section of this guide for details.

Mounting

Once a mounting location has been selected installation can begin. The Model 742A requires one space (1.75 vertical inches or "1U") in a standard 19-inch (48.3 cm) equipment rack. Secure the unit into the equipment rack using four mounting screws, two per side.

Mic/Line Inputs

The Model 742A contains four input channels that are compatible with microphone and line-level sources. (Refer to Figure 3 for a detailed view.) Each input uses a 3-pin female XLR connector. Prepare the mating connectors (males) so that pin 2 is signal high (+ or hot), pin 3 is low (– or cold), and pin 1 is shield.

It's possible that some of the mic/line inputs will be wired to an input/output (I/O) panel located on the side or rear of a broadcast vehicle. If this is the case, it's also nice to have one or two of the inputs "muled" to connectors inside the vehicle. This will allow the rapid connection of microphone or line-level signals during specialized situations. For example, during inclement weather on-air talent may wish to connect a microphone to the Model 742A from inside a vehicle.

To minimize potential hum or noise problems, it is recommended that microphone-level signals connected to the mic/line

Model 742A

Audio Mixer

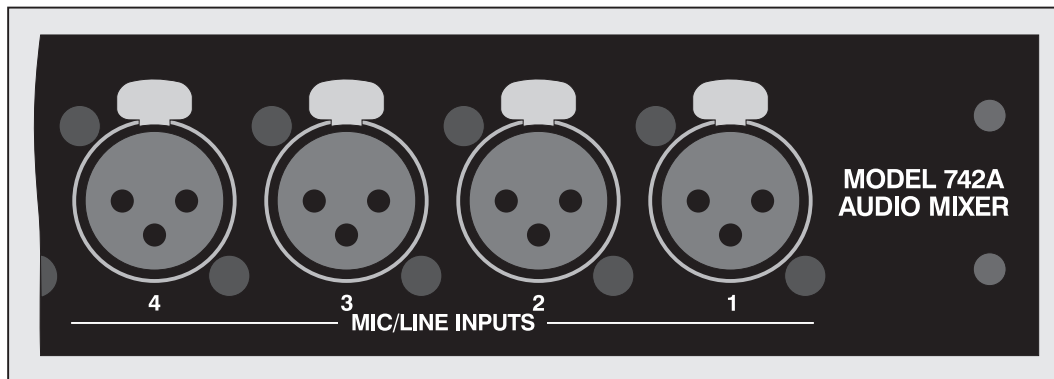

Figure 3. Detail of back panel showing mic/line input connectors

inputs not be wired by way of points on an audio patch bay. It certainly can be done, but the possibility for intermittent connections, especially in mobile applications, may significantly increase.

Line Inputs

The Model 742A contains four line-level input channels. (Refer to Figure 4 for a detailed view.) Each input uses a 3-pin female XLR connector. Prepare the mating connectors (males) so that pin 2 is signal high (+ or hot), pin 3 is low (– or cold), and pin 1 is shield. Unbalanced signals can also be connected. In this case, pin 2 is connected to signal high (+ or hot), and pins 1 and 3 are connected to shield. If this results in hum or other noise being

present, try connecting pin 2 to signal high and shield to pin 3; leave pin 1 unconnected (“floating”). To provide maximum flexibility, it is recommended that the signals connected to the line inputs be wired by way of points on an audio patch bay.

Main Outputs

The Model 742A contains two main outputs which are directly associated with output buses 1 and 2. (Refer to Figure 5 for a detailed view.) They are electronically balanced, capacitor coupled, with a nominal level of +4 dBu. The output circuitry is capable of driving balanced or unbalanced loads of 600 ohms or greater. Note, however, that as the load impedance approaches 600 ohms the output levels

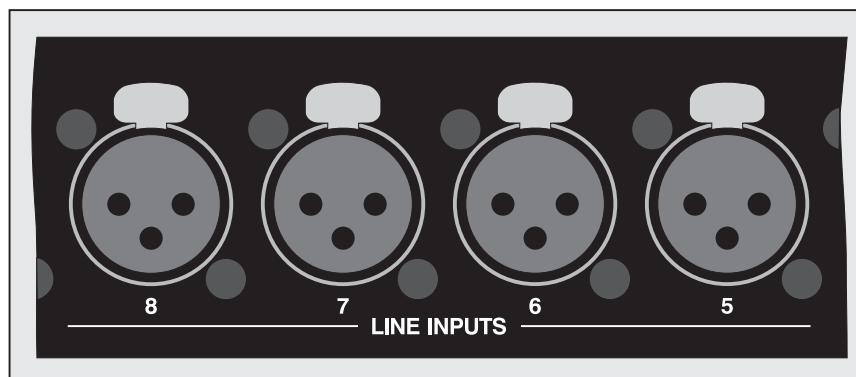

Figure 4. Detail of back panel showing line input connectors

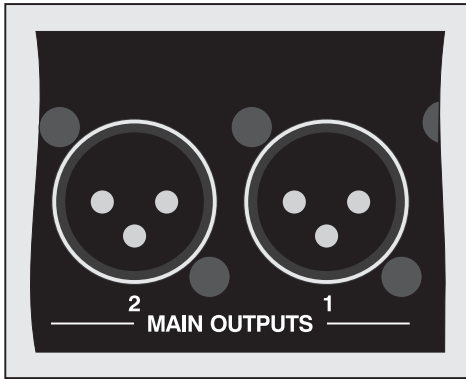

Figure 5. Detail of back panel showing main output connectors

will drop slightly. A 0.5 dB difference in output level can be expected as the load impedance changes from 10 k ohms to 600 ohms. This loading situation applies to the monitor outputs and reference tone direct outputs as well.

Note that the main outputs are intended only for connection to devices located within a broadcast vehicle or dedicated indoor facility. While the circuitry used in the outputs is robust and sonically excellent, they're not intended for direct exposure to the extreme conditions that can occur in the nasty "outside world." This limitation is normally not an issue as the main outputs will typically be connected to inputs on a distribution amplifier. Should the main outputs need to be connected directly to a vehicle's I/O panel, it's recommended that one-to-one isolation transformers be placed in their signal paths. Ensure that any transformer selected is specified for use in line-level, rather than just microphone-level, applications.

The main outputs utilize 3-pin male XLR connectors for interconnection. Prepare the mating connectors (females) so that pin 2 is signal high (+ or hot), pin 3 is low (- or cold), and pin 1 is shield. Whether

these outputs are wired via a patch bay will depend on the specific installation. But at least having "mults" of the main outputs on patch points is probably a good idea.

While balanced operation is generally preferred, unbalanced operation is not a problem for the output circuitry. To connect to unbalanced loads prepare the mating connectors so that pin 2 is high (+ or hot), and both pins 1 and 3 are shield. For optimal unbalanced operation, it is important to connect pins 1 and 3 together directly on the connector that mates with the Model 742A, not at the other end of the cable.

Monitor Outputs

The monitor outputs are designed to connect to a variety of devices. In some applications they will connect to an audio power amplifier associated with a set of monitor loudspeakers. In mobile applications it's popular to use loudspeakers with an internal amplifier, such as those from Fostex. And, depending on how the monitor outputs are internally configured, they can also serve as a second set of +4 dBu nominal main outputs.

The monitor outputs are electronically balanced, capacitor coupled, and line-level. They can drive balanced or unbalanced loads of 600 ohms or greater. Configuration jumpers allow the monitor outputs to be set from among three operating modes. In the "post" mode the output levels are dependent upon the settings of the front-panel level controls. In the "pre -10" mode the monitor outputs have a fixed nominal output level of -10 dBu. In this mode, the nominal output level has been optimized to match the input sensitivity typically found on amplified loudspeakers.

In the “pre +4” mode the monitor outputs have a fixed nominal output level of +4 dBu.

The monitor outputs utilize ¼-inch 3-conductor jacks for interconnection.

(Refer to Figure 6 for a detailed view.)

Prepare the mating connectors (plugs) so the tip is signal high (+ or hot), ring is low (– or cold), and sleeve is shield. To connect to an unbalanced load connect tip to high (+ or hot) and both ring and sleeve to shield. Whether or not these outputs are wired via a patch bay will depend on the specific installation. In most cases they will not be.

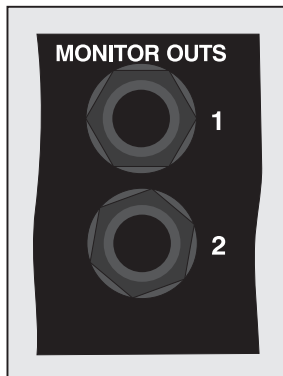

Figure 6. Detail of back panel showing monitor output connectors

Reference Tone Direct Output

Direct access to a continuous source of sine-wave reference tone is provided by means of a line-level output. As one of the unique features of the Model 742A, it should definitely be utilized! This output is intended to be connected to an audio input associated with a audio/video switcher’s “bars and tone” position. For maximum flexibility, it is recommended that this signal be routed via a patch bay. In this way it can be easily accessed for other test and calibration purposes.

The reference tone direct output is electronically balanced, has a nominal +4 dBu level, and is accessible via a ¼-inch 3-conductor jack which is located on the back panel. (Refer to Figure 7 for a detailed view.) The output circuitry is capable of driving a balanced or unbalanced load of 600 ohms or greater. Prepare the mating plug so that tip is signal high (+ or hot), ring is low (– or cold), and sleeve is shield. To connect to an unbalanced load connect tip to high (+ or hot) and both ring and sleeve to shield.

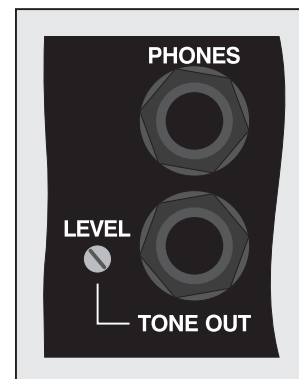

Figure 7. Detail of back panel showing reference tone direct output connector, associated level trim pot, and headphone output jack

A trim potentiometer, accessible from the back panel, can be used to set the precise level of the reference tone direct output. After an installation has been completed it may be desirable to set the trim pot to provide the required level. For details please refer to the Post-Installation Calibration section of this user guide.

Headphone Output

The Model 742A contains one headphone output which is located on the back panel. (Refer to Figure 7 for a detailed view.) The output jack is a ¼-inch 3-conductor (“stereo”) tip-ring-sleeve type. The audio

source for the tip lead (typically headphone left) is main output bus 1. The audio source for the ring lead (typically headphone right) is main output bus 2. The levels of the two channels of the headphone output are adjusted using the dual-knob front-panel control.

Locating the headphone jack on the back panel allows the installation of a remote headphone jack at the exact desired location. This eliminates having to plug headphones into the usual location on the front panel of an audio mixer, which itself is typically mounted in a very crowded rack. The problem of a draped headphone cord that is easily snagged or tangled won't occur. As a suggestion, locating a headphone jack on an I/O panel associated with a PC-based editing location, voice-over area, etc., can prove very useful.

There may be cases where the headphone output may need to support a monaural earpiece, such as at a talent voice-over position. In this case, simply connect only the tip and sleeve terminals for main output bus 1 or the ring and sleeve terminals for main output bus 2 on the 3-conductor plug used to mate with the Model 742A's back-panel jack. Don't use a 2-conductor (mono) plug as the headphone output for main output bus 2 will be shorted.

Connecting AC and/or DC Power

The Model 742A requires a source of AC mains or 10 to 18 volts DC for operation. Either source can be connected with the same result. Both can also be simultaneously connected if a redundant (backup) power scheme is desired.

Connecting AC Mains Power

The Model 742A operates directly from AC mains power of 100 to 240 volts, 50/60 hertz, 15 watts maximum. As a "universal mains input" device, there are no switches to set or jumpers to install. A 3-pin IEC 320 C14 inlet connector on the back panel mates with a detached mains cord set. (Refer to Figure 8 for a detailed view.)

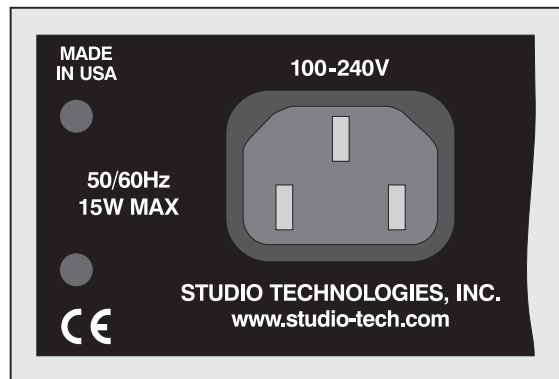

Figure 8. Detail of back panel showing AC mains power connector

All units are supplied with an AC mains cord that has a North-American (NEMA 5-15L) standard plug on one end and an IEC 320 C13 connector on the other end. Units bound for other destinations require that the appropriate cord set be obtained. The wire colors in the mains cord should conform to the internationally recognized color code and be terminated accordingly:

<u>Connection</u>	<u>Wire Color</u>
Neutral (N)	Light Blue
Line (L)	Brown
Earth/Ground (E)	Green/Yellow

Because the Model 742A does not contain a power on/off switch it will begin operation as soon as AC mains power is connected. To confirm that the Model 742A is operating the LED indicator labeled PWR/TONE will light. This LED is located

below the tone function's on/off switch on the front panel. (Refer to Figure 9 for a detailed view.)



Figure 9. Detail of front panel showing the power/tone LED indicator

Safety Warning: The Model 742A does not contain an AC mains disconnect switch. As such, the AC mains cord plug serves as the disconnection device. Safety considerations require that the plug and associated inlet be easily accessible to allow rapid disconnection of AC mains power should it prove necessary.

Connecting DC Power

The Model 742A can also operate from a source of 10 to 18 volts DC. The current required from a 12 volt DC source is 0.9 ampere maximum. (A source of 10 volts DC needs to supply 1.1 amperes maximum.) A 4-pin male XLR connector, located on the unit's back panel, is used to connect the source of DC. (Refer to Figure 10 for a detailed view.) Prepare a mating connector (female) so that pin 1 is – DC and pin 4 is +DC. Pins 2 and 3 are not used and should remain unconnected. This connector type and pin-out are rapidly becoming a broadcast DC power

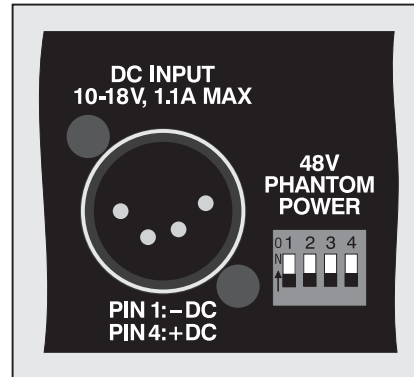

Figure 10. Detail of back panel showing the DC input power connector

standard and should be familiar to many technical personnel.

Because the Model 742A contains no power on/off switch it will begin operation as soon as a DC power source is connected. To confirm that the Model 742A is operating the LED indicator labeled PWR/TONE will light. This LED is located below the tone function's on/off switch on the front panel. (Refer to Figure 9 for a detailed view.)

As previously mentioned, both an AC mains source and a DC source can be connected at the same time. If this is the configuration then the AC mains source will always power the Model 742A with the DC source serving as a “hot standby.” Only if the AC source fails will the unit draw power from the DC source. This will occur automatically with no interruption of Model 742A operation. There should be no problem with a battery being connected as a standby power source. In this “backup” mode there will be no continuous current draw that will significantly discharge it. This is because the Model 742A draws less than 100 microamperes (μA) from the DC input when an AC mains source is connected.

Post-Installation Calibration

Reference Tone Direct Output

If the reference tone direct output is used, it is important to confirm that its output level is correct for the installation. In most cases, the output level will need to be adjusted to match the precise requirement of the system. This is because the load applied to the output may very well be different from the 100 k ohm load that is applied during testing at the factory. As previously noted, while the output circuitry is capable of driving loads of 600 ohms or greater, the output level will drop slightly as the load impedance changes, especially as it approaches 600 ohms.

Depending on the Model 742A's internal configuration the tone frequency will be either 400 Hz or 1 kHz. A trim potentiometer allows adjustment of the output level over a range of approximately +3 to +7 dBu. The trim pot is accessible by way of a small access hole in the back panel, adjacent to the reference tone direct output's ¼-inch jack. (Refer to Figure 7 for a detailed view.) At the factory this output is loaded with 100 k ohms and then the trim pot is adjusted to give an output level of +4 dBu.

In practice, calibrating the output level is quite simple:

1. Confirm that the reference tone direct output is terminated with its installation-specific load impedance.
2. Ensure that the Model 742A is connected to a source of AC mains or DC power.
3. Using an appropriate adapter cable, connect a high-input-impedance audio level meter directly across the reference tone direct output. Ensure that this meter connection does not remove the normal load! The level meter must be a precision device that's intended for audio use—a general-purpose voltmeter is not adequate!
4. While carefully observing the level meter, adjust the trim pot to give the desired output level.

Labeling the Unit for Clarity

Once the Model 742A has been installed, installation-specific labeling of the front panel may want to be performed. (Refer to Figure 11 for a detailed view.) This additional clarity can greatly assist operators in correctly using the unit. For example, instead of the first line input channel having the factory-standard text INPUT 5, it could reflect its exact function, such as TAPE 1. The unit's front-panel graphics were specifically created to simplify the task of adding custom labels. Each front-panel section heading text is underlined with a horizontal green line, which, besides looking pretty sharp, is intended to serve as a "guide" for adding installation-specific labels. The distance from the guide line to the top of the front panel was specifically designed to allow ¼-inch-high label material to fit correctly.

For a great look it's recommended that Brother® P-Touch ¼-inch (6 mm) labels be created. Selecting tape material that prints white text on a black background works out perfectly for the Model 742A. The Brother label cassette number TX-3151, white on black, is appropriate for use with some of their printers.

Model 742A

Audio Mixer



Figure 11. Detail of front panel showing installation-specific labeling

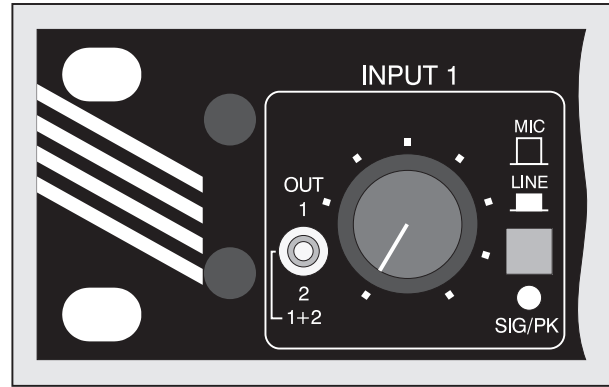

Figure 12. Detail of front panel showing one mic/line input channel (typical of four)

Operation

While the Model 742A Audio Mixer is quite simple to operate, there are nuances in its design that make a detailed discussion worthwhile. We'll start with the individual sections that make up the Model 742A, then we'll review how the sections work together to become your audio "master control."

Mic/Line Inputs

Four identical mic/line input channels are provided, each being compatible with microphone and line-level signals. (Refer to Figure 12 for a detailed view of one of the mic/line input channel sections.) The following provides a detailed description of one of the mic/line inputs:

Input Sensitivity

The input circuitry is compatible with a wide range of signal levels, as well as being protected from overload. The mic/line push-button is used to select the sensitivity of the input. In the mic (out) position, the expected nominal input level range is -55 to -35 dBu. In the line (in) position, a 44 dB pad is inserted into the circuit, making the expected nominal input level range -12 to $+8$ dBu.

Phantom Power

In most broadcast news and general-audio applications, phantom-powered condenser microphones are not utilized. However, this is not always the situation and the Model 742A does allow 48 volt phantom power to be supplied to the four mic/line input channels. Four DIP switches, accessible on the back panel, allow +48 volt phantom power to be individually selected for each mic/line input. The labeling on the DIP switches, 1 through 4, corresponds with the mic/line input channels. Placing a switch in its on (up) position enables phantom power for its respective channel. (Refer to Figure 13 for a detailed view.)

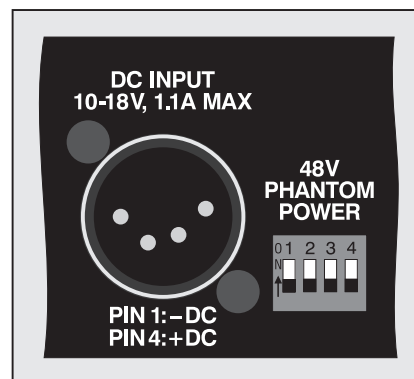

Figure 13. Detail of back panel showing the +48 volt phantom power DIP switch

If phantom power is enabled for a channel it is only active when the channel's mic/line input sensitivity switch is set to its mic (out) position. Phantom power is not available in the line position. Note that when phantom is selected for an input channel it's normal for a slight "click" or "pop" to be heard when moving that input's sensitivity switch between the mic and line positions, and vice-versa. This noise, while slightly annoying, will not harm the circuitry. It also provides an aural indication that phantom power is available. (It's not a technical limitation, it's a feature!)

Status LED

A dual-color LED acts as a user-confidence indication of the overall signal level in the mic/line input channel's circuitry. The LED will light green as a signal present indicator, showing that the input signal, along with the gain of the input preamplifier, is at least 18 dB below the nominal internal operating level. The LED will light red as a peak signal indicator, showing that the input signal, along with the gain of the preamplifier, is within 6 dB of the circuitry's maximum level.

Level Control

The rotary control is used to adjust the gain of the input section's preamplifier circuitry. It also controls the amount of signal that can be sent to the output bus (or buses). In the fully counterclockwise position the preamplifier gain is set to its minimum, and full attenuation to the bus (or buses) is achieved. This means that no signal continues on to the mixing circuitry that creates the main outputs. As the level control is rotated in the clockwise direction the gain of the preamplifier increases, as does the level of the signal sent to the selected output bus (or buses).

Output Assignment Switch

A 3-position toggle-type switch is used to assign which of the output buses the signal will be routed to. In the "up" position the signal is sent only to output bus 1. In the "down" position the signal is sent only to output bus 2. In the "center" position the signal is sent to both output buses 1 and 2.

Line Inputs

Four identical line-level input channels are provided. (Refer to Figure 14 for a detailed view of one of the line input channel sections.) The following provides a detailed description of one of them:

Status LED

A dual-color LED acts as a user-confidence indication of the overall signal level in the circuitry associated with the line-level input. The LED will light green as a signal present indicator, showing that the input signal, along with the gain or loss of the input amplifier, is at least 18 dB below the nominal internal operating level. The LED will light red as a peak signal indicator, showing that the level is within 6 dB of the circuitry's maximum.

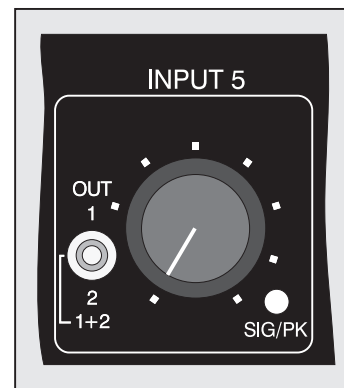

Figure 14. Detail of front panel showing one line input channel (typical of four)

Level Control

The rotary control is used to adjust the overall gain or loss of the line input's amplifier circuitry, thus setting the amount of signal that is sent to the output bus (or buses). In the fully counterclockwise position the amplifier gain is set to its minimum, and full attenuation is achieved. This means that no signal continues on to the mixing circuitry that creates the main outputs. As the level control is rotated in the clockwise direction the gain of the preamplifier increases, as does the level of the signal sent to the selected output bus (or buses).

Output Assignment Switch

A 3-position toggle-type switch is used to assign which of the output buses the signal will be routed to. In the up position the signal is sent only to output bus 1. In the down position the signal is sent only to output bus 2. In the center position the signal is sent to both output buses 1 and 2.

Master Section/Main Output Buses

The Model 742A's master section supports output buses 1 and 2 with several controls and switches, compressor circuitry, and level and status indications. The following sections provide detailed descriptions of each of them. (Refer to Figure 15 for details.)

Master Level Controls

Two rotary controls are used to set the overall level of output buses 1 and 2. The controls are "concentric" type, with the inner knob controlling bus 1 and the outer knob controlling bus 2. On the front panel, note the graphic symbol and the letter "U," located at the "12-o'clock" rotational position. This indicates the correct setting to

provide unity gain through the circuitry, and is the position where the controls should normally be set.

Compressor

Studio-quality compressor circuits are associated with the two output buses. A yellow LED, located to the right of each LED meter, will light whenever its respective compressor is controlling the dynamic range of the output bus. The operating threshold of the compressors and associated LEDs depends on how the Model 742A has been configured:

- From the factory the compressor thresholds are set to be 6 dB over the Model 742A's nominal output level of +4 dBu. This correlates to a level on the main output connectors of +10 dBu.
- The compressors' configuration can also be revised so that thresholds of 2 dB over nominal are selected. This correlates to a nominal level on the main output connector of +6 dBu. With this configuration the compressors may be active quite frequently during typical Model 742A operation.
- A third configuration is also available which serves to disable the compressors. In this case dynamic range control will never take place and the LEDs will never light.

If the compressors are set to use one of the two thresholds, i.e., +10 or +6, the compressor active LEDs should prove useful. With the input and master level controls set correctly, the compressor active LEDs will typically light only when peak signals are present. In an "ideal" world where maximum audio fidelity is the goal, the LEDs should rarely, if ever, light.

Model 742A

Audio Mixer

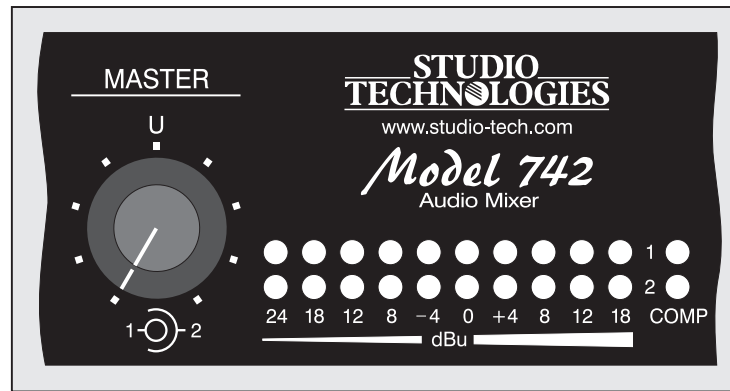

Figure 15. Detail of front panel highlighting master level controls, 10-segment LED level meters, and compressor active LEDs

Level Meters

Two 10-segment LED meters display the level present on main outputs 1 and 2. Each meter has seven green LEDs which light in the presence of signals in the normal operating range. Two yellow LEDs light with signals slightly higher in level than normal. One red LED lights whenever the signal level is in the “headroom” area. The ballistics of the meters is a cross between that of VU and a peak (PPM) meters. (We affectionately refer to them as “PU” meters!) The way the LEDs “move” in response to signals should be comfortable for most users to observe.

While the meters are easy to interpret, they are somewhat different from ones that are marked with “VU” nomenclature. The important thing to remember is that the steps show level in dBu, rather than VU units. So, for example, when the meter step that is labeled “0” lights, it indicates that 0 dBu is present on its associated main output connector. It doesn’t indicate 0 VU! (Remember that 0 VU typically indicates a device’s reference operating level—often +4 dBm.)

The seven green LEDs in each meter display a dynamic range of 28 dB, with thresholds of -24 dBu, -18 dBu, -12 dBu, -8 dBu, -4 dBu, 0 dBu, and +4 dBu. This is the range that typical signals should display if correct settings have been made to the input sensitivity switches, input level controls, and master level controls. The two yellow LEDs light when a signal level has exceeded the Model 742A’s nominal +4 dBu output level. Their thresholds are +8 dBu and +12 dBu, well within the capabilities of the unit’s circuitry. The red LED will light when signal on the main output meets or exceeds +18 dBu. This is dangerously close to the Model 742A’s maximum output level and should be avoided.

But now back to reality when it comes to how the meters will function during actual Model 742A use. To a great degree meter activity will depend on how the compressors have been configured to operate. As discussed in previous sections of this user guide, a technician can set the Model 742A’s compressors to operate from one of three modes:

- If the factory-default compressor threshold of +10 dBu is in effect, normal audio content will cause each meter to display a small to moderate amount of dynamic range control. The yellow level LEDs may light on peak signal levels, along with the compressor active LED. The red LED will essentially never light.
- If the thresholds are set for +6 dBu, typically only a meter's first yellow LED will light. The second yellow LED will rarely light; the red LED will probably never light. With this configuration there often may be a large amount of dynamic range control being performed by the compressors. Obviously the goal in this case is for the operator to carefully set the Model 742A's controls so that the signal level generally stays below the compressor's threshold. But with the fairly low threshold of +6 dBu, it may be difficult to not have the compressors active almost all the time.
- If the compressors have been configured not to function (disabled), the meters will get their biggest workout. Depending on the setting of the input and master output controls, all ten segments of each meter may often come into play.

Reference Tone

A sine-wave tone can be connected to the two output buses, serving as a reference signal for local and remote use. A pushbutton switch selects its status; when the switch is in its on (in) position tone is connected to both output bus 1 and 2. A dual-color LED indicator, which is located directly below the switch, lights red whenever tone is being sent to the main buses. (The LED lights green when the Model

742A is operating and the tone is not assigned to the output buses.) The level of the tone generation circuitry is adjusted at the factory to match the Model 742A's internal operating level. When the tone is connected to the output buses, the master level controls should be adjusted to give +4 dBu indications on the level meters. (Refer to Figure 16 for a detailed view.)



Figure 16. Detail of front panel showing reference tone on/off button and reference tone active LED

Monitor Section

The monitor section can assist an operator in obtaining the best performance from the Model 742A and associated equipment. The monitor section supports the connection of both a loudspeaker system and a headphone device. The two monitor outputs are line-level and designed to be connected to audio power amplifier channels and associated loudspeakers. Alternatively, they can be connected to “amplified” loudspeakers that contain internal power amplifiers. The headphone output, located on the back panel, is designed to support stereo devices.

Monitor output 1 and the left channel of the headphone output use output bus 1 as their audio source. Monitor output 2 and the right channel of the headphone output

use output bus 2 as their audio source. Two rotary controls set the output levels of the headphone channels and, depending on the Model 742A's configuration, may also control the level of the monitor loudspeakers. Understanding and becoming comfortable with using the monitor section is important in obtaining optimal Model 742A performance. (Refer to Figure 17 for a detailed view.)

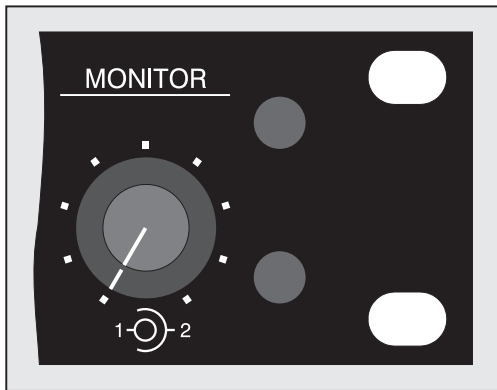

Figure 17. Detail of front panel showing monitor output level controls

Level Controls

The rotary controls are always used to adjust the output level of the headphone output channels. Like the master output controls, they are concentric—the inner knob controlling channel 1 and the outer knob channel 2. Depending on how the monitor output mode is configured, the rotary controls may also adjust the levels of the connected loudspeakers. There are three ways that the monitor output can be configured:

- From the factory the monitor output is configured to follow the position of the front-panel level controls (“post” level controls). In this mode the front-panel controls are used to adjust the levels of the monitor outputs, and thus the monitor loudspeakers.

- A second configuration mode takes the Model 742A's front-panel level controls out of the picture vis-à-vis the monitor outputs. It does this by setting the nominal level of the monitor outputs at a fixed value of -10 dBu. In this mode the level controls on the connected amplifier channels, or amplified loudspeakers, are used to adjust the loudspeaker levels.
- A third configuration mode also takes the Model 742A's front-panel level controls out of the picture. In this case the nominal level of the monitor outputs is fixed at $+4$ dBu. Again in this mode the level controls on the connected amplifier channels, or amplified loudspeakers, are used to adjust the loudspeaker levels.

Headphone Output

The headphone output is designed to work well with virtually any of the contemporary medium- and high-impedance stereo headphones. Sony headphones were used during the design of the Model 742A; their high sensitivity made them go “way loud”! (While a bit “bright” in the high-end for our taste, their comfort and fine design make them a good choice for use with the Model 742A.) Using the headphone output to monitor the Model 742A is a bit different than monitoring a typical “stereo” audio source. This is because the audio source for the left channel of the headphone output is always output bus 1 while the audio source for the right channel is output bus 2. This means that the monitor level controls will be used not only to set the overall headphone output levels, but also to select which output bus or buses are going to be monitored.

Warning: Protect your ears! The Model 742A is capable of driving headphones to extremely high sound pressure levels. Hearing experts encourage caution against continuous extended play, especially at high levels. Polka music has been found to be especially dangerous, so please be careful.

Practical Operating Tips

Now that we've reviewed all the sections that comprise the Model 742A, it's time to actually use the unit. The following paragraphs provide suggestions regarding how to best use the Model 742A.

Setting the Output Bus Operating Levels

The two output bus master level controls allow the overall gain structure of the main audio buses to be set. Correctly setting these controls ensures that the best audio quality will be achieved. In most cases simply setting both controls to the unity gain position is appropriate; the unity gain position is clearly marked with a "U" on the front panel.

Signal Present/Peak LEDs

Dual-color status LEDs are associated with each of the four mic/line inputs as well as the four line-level inputs. Simply stated, lighting green is fine, lighting red is bad. When a mic/line input channel has its input sensitivity (mic/line) switch and level control set correctly only the LED's green color should light. Each line-level input channel should have its level control set so that only the LED's green color lights. With both types of input channels, signal peaks may cause an occasional red "flash," but sustained red lighting

indicates that audio performance is being compromised.

Compressor Active LEDs

Compressor active LEDs, one for each output bus, are located directly to the right of the level meters. They will light with a yellow color whenever dynamic range control is taking place. If the compressors have been configured not to operate (disabled) then obviously the LEDs will never light. If the compressors are enabled, typical operation should find the LEDs lighting on occasion, or even frequently, on signal peaks. But the LEDs should never light continuously. If this is the case the input level controls should be adjusted to reduce the amount of signal being sent to the audio buses. Also, the position of the master level controls should be checked to ensure that they are set correctly. In most cases they should be set to the reference position, marked "U" for unity gain.

Technical Notes

Configuration Changes

Warning: A competent technician is required to perform any configuration review or changes. The cover of the Model 742A must be removed to access the configuration jumpers. This exposes the technician to a potential shock hazard. Only after AC mains power has been disconnected and the mains cord removed from the back of the Model 742A should the cover be removed. If a DC source is connected it should be removed at this time also. Four screws, two on each side of the chassis, are used to secure the cover.

Compressor Configurations

The compressor circuits that control the dynamic range of the main output buses can be configured to operate from one of three modes. Two configuration jumpers, one for each compressor circuit, are used to select which mode is active. From the factory the jumpers are placed across the pins labeled +10 dBu. This sets the thresholds to be 6 dB above the main outputs' +4 dBu nominal output level. Moving the jumpers to the +6 dBu positions sets the thresholds to be 2 dB above the +4 dBu nominal output level. To disable compressor operation place the jumpers on the pins labeled OFF. Finding the compressor configuration locations is not difficult. When viewed with the cover off, they are located near the center of the printed circuit board. The jumper sections are labeled COMPRESSOR 1 and COMPRESSOR 2. The factory default has the jumpers set to their +10 dBu positions.

Monitor Output Configurations

The monitor section's line-level outputs are configured to operate from one of three modes. Two configuration jumpers, one for each monitor output, are used to select the desired mode. From the factory the jumpers are placed across the pins labeled POST. This configures the monitor outputs so that they are after ("post") the level controls. Moving the jumpers to the PRE -10 locations sets the monitor outputs to be electrically before ("pre") the level controls and to have a nominal level of -10 dBu. This is appropriate when connecting the monitor outputs to the inputs of most amplified loudspeakers. Moving the jumpers to the PRE +4 locations sets the monitor outputs to be "pre" the level controls but with a +4 dBu nominal level.

This mode allows the monitor outputs to serve as an additional set of line-level main outputs. Finding the configuration locations for the monitor outputs is not difficult. When viewed with the cover off, they are located at the back of the printed circuit board, near the 1/4-inch 3-conductor jacks that are associated with the monitor outputs. The jumper sections are labeled MONITOR 1 and MONITOR 2. The factory default has the jumpers set to the POST positions.

Reference Tone Frequency Configuration

Two configuration jumpers are used to select the nominal frequency range of the reference tone oscillator. A trim potentiometer is then used to set the frequency to the exact desired value. From the factory the frequency of the reference tone is set to be 400 Hz. This was accomplished during the initial factory testing process in two steps. The first step was to set the jumpers to the two locations that are labeled 400 Hz. Then the trim pot labeled **FREQ** was adjusted so that a 400 Hz signal was generated, as measured at the 1/4-inch 3-conductor tone output jack.

To change the frequency to 1 kHz start by moving the jumpers to the positions labeled 1 kHz. Then apply power to the Model 742A using a DC source in the range of 10 to 18 volts. (Do not connect an AC mains source as this exposes the technician to a safety hazard!) Then, using a frequency counter or other measuring device, adjust the trim pot labeled **FREQ** so that a 1 kHz signal is present at the 1/4-inch 3-conductor tone output jack. Finding the reference tone frequency configuration location on the printed circuit board is not difficult. When viewed from the front

with the cover off, it is located on the far right side of the printed circuit board, adjacent to the DC power input 4-pin XLR connector. It is labeled **FREQ**.

Be careful not to adjust the trim pot that is labeled **LEVEL**. This adjusts the output level of the oscillator to give precisely -2 dBu to the main audio buses when the front-panel tone button is enabled. Should this pot have to be readjusted the procedure is quite simple: measure from pin 1 (common) to pin 2 (audio) of the 3-pin header labeled **P5 FACTORY** and adjust the level trim pot to give -2 dBu. The measurement equipment must have a high input impedance (>2 k ohms) so as not to load the oscillator's output.

Model 742A Feature Set

The Model 742A was carefully designed with simplicity of operation in mind. Only the required features and functions were included. The goal was reliable audio performance with little risk that operator confusion or errors would occur. Protecting the audio signals associated with live news "shots" was foremost on the list of requirements. The Model 742A's design team spent lots of time making lists of what features could be included, only to be told by field personnel that everything that wasn't absolutely required should stay out! Here's a review of several common features that weren't included and the reasons why:

- Including high-pass (low-cut) filters on the mic/line inputs was a possibility. But in the "heat of battle" it's unlikely that an operator will have the time to enable them. Also, these functions require another four front-panel switches for high-pass enable/disable selection.

More switches can lead to more operator error! If wind noise is an issue, microphone selection (or adding a windscreen) will often resolve the issue. Alternately, personnel "down stream" in an editing suite or at a live audio console can typically apply a high-pass filter as required.

- Allowing an operator front-panel adjustment of the compressor functions was certainly a possibility. But frankly, it would guarantee that audio performance would often be compromised. The Model 742A's compressor circuits were optimized for the unit's intended applications. The compression ratio, nominally 5:1, is very effective in controlling the dynamic range of voice signals, the primary application for the unit. The attack and release times were also carefully selected for overall excellent performance. A typical user is not in a position to, "on the fly," improve compressor performance. In addition, no operator-accessible compressor on/off switches are provided. If at the time of installation the "powers that be" make the decision that dynamic range control is desired, the internal jumpers are configured accordingly. From then on "hands off" operation will take place.

Definition of Level

Studio Technologies has opted to use the dBu designation. Using dBm was fine when all audio outputs were terminated with 600 ohm loads. In this way it was easy to say that "0 dB" was 1 milliwatt dissipated in the known load (i.e., 0 dBm across 600 ohms will measure 0.775 V). Today, an output is rarely terminated with 600 ohms; generally 10 k ohms or higher.

The dBu designation is better because it refers to dB referenced to 0.775 V, with load impedance not a factor. This takes into account the contemporary audio scene where most equipment has a low output source impedance and a high input impedance.

Mic/Line Switching

As previously discussed, the four mic/line input circuits can be selected for compatibility with microphone or line-level signals. For compatibility with line-level signals a 44 dB balanced attenuator (“pad”) is connected between an input connector and its associated microphone preamplifier circuit. Front-panel pushbutton switches are used to select whether the pads are bypassed (mic input setting) or active (line input setting).

While the switches are conveniently located on the front panel, audio does not actually pass through them. Instead, the audio signals are routed through sealed, bifurcated contact electromechanical relays. These subminiature relays are located very close to the mic/line input connectors, minimizing the chance of picking up unwanted hum or noise and helping to maintain good common-mode rejection. The relays should prove to be very reliable, being designed for telecom use where typical operating life is in the millions of cycles.

Specifications

General Audio Parameters:

Frequency Response: 20 Hz to 20 kHz, ± 0.5 dB, mic/line in to main outs

Distortion (THD+N): 0.03 %, measured at 1 kHz, +4 dBu, mic/line in to main outs

S/N Ratio: 74 dB, referenced to +4 dBu, mic/line in to main outs, 22 Hz to 22 kHz

Mic/Line Inputs: 4

Input Sensitivity: switch selectable for microphone or line-level signals; 44 dB line input “pad” implemented using sealed bifurcated contact telecom relays

Phantom Power: 48 Vdc, nominal, meets IEC 61938 P48 standard

Operating Level Range: mic input position: -76 to -8 dBu; line position: -32 to $+28$ dBu. Range specified to give +4 dBu on main outs, master level controls set to unity gain.

Type: electronically balanced

Impedance: mic position 1.3 k ohms, line position 15 k ohms

Common Mode Rejection Ratio: 74 dB @ 60 Hz, 73 dB @ 40 kHz (typical), mic position, ref +4 dBu on main outs

Status LED: dual-color, displays signal present and peak

Line Inputs: 4

Operating Level Range: -14 to $+28$ dBu. Range specified to give +4 dBu on main outs, master level controls set to unity gain.

Type: electronically balanced

Impedance: 24 k ohms, nominal

Common Mode Rejection Ratio: 85 dB @ 60 Hz, 85 dB @ 40 kHz (typical), ref +4 dBu on main outs

Status LED: dual-color, displays signal present and peak

Compressors: 2

Function: controls dynamic range of output buses 1 and 2

Type: single-knee, VCA-controlled

Slope: 5:1

Threshold: configurable, choices are: 6 dB over nominal (+10 dBu on main output, factory default); 2 dB over nominal (+6 dBu on main out); disabled

Attack Time: 2 ms

Release Time: 100 ms

Status LEDs: 2, compressor active

Main Outputs: 2

Type: electronically balanced, capacitor-coupled, intended to drive balanced or unbalanced loads of 600 ohms or greater

Source Impedance: 50 ohms, nominal

Nominal Level: +4 dBu

Maximum Level: +26 dBu into 10 k ohms, +25 dBu into 600 ohms

Monitor Outputs: 2

Signal Sources: output buses 1 and 2

Type: electronically balanced, capacitor-coupled, intended to drive balanced or unbalanced loads of 600 ohms or greater

Source Impedance: 50 ohms, nominal

Nominal Level: configurable, choice are: +6 dBu, with monitor level control @ 100%, mode configured for POST level control; -10 dBu when configured for PRE -10 ; +4 dBu when configured for PRE +4

Maximum Level: +26 dBu into 10 k ohms, +25 dBu into 600 ohms

Headphone Output:

Signal Sources: output buses 1 and 2 (“post” monitor level controls)

Type: stereo, configured to drive headphones through 100 ohm series resistors

Compatibility: intended for connection to headphones with impedance of 100 ohms or greater

Maximum Voltage: 8 Vpp, 100 ohm load

Model 742A

Audio Mixer

Reference Tone:

Frequency and Wave Form: 400 Hz nominal, sine wave (technician can revise to 1 kHz)

Direct Output Level: +4 dBu, nominal, adjustable over -1/+3 dB range

Direct Output Type: electronically balanced, capacitor-coupled, intended to drive balanced or unbalanced loads of 600 ohms or greater

Direct Output Source Impedance: 100 ohms, nominal

Meters: 2

Function: displays level of output buses 1 and 2

Type: 10-segment LED, modified VU ballistics

Connectors:

Mic/Line and Line Inputs: 3-pin female XLR

Main Outputs: 3-pin male XLR

Reference Tone Direct Output, Monitor Outputs, Headphone Output: ¼-inch 3-conductor phone jack

AC Mains Input: 3-blade, IEC 320 C14-compatible (mates with IEC 320 C13)

DC Input: 4-pin male XLR

AC Mains Input: 100-240 volts (-15/+10%), 50/60 Hz, 15 W maximum

DC Input: 10-18 volts DC, 0.9 A maximum @ 12 volts; 1.1 A maximum @ 10 volts; current draw when AC present is less than 100 uA

Dimensions (Overall):

19.0 inches wide (48.3 cm)

1.72 inches high (4.4 cm)

9.2 inches deep (23.4 cm)

Mounting: one space (1U) in a standard 19-inch rack

Weight: 4.3 pounds (1.9 kg)

Specifications and information contained in this User Guide subject to change without notice.

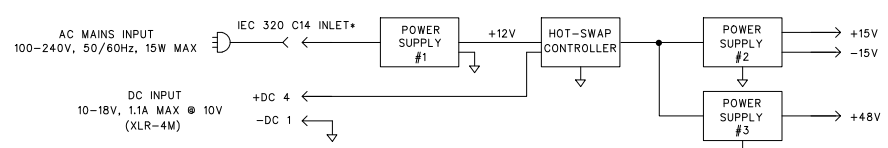
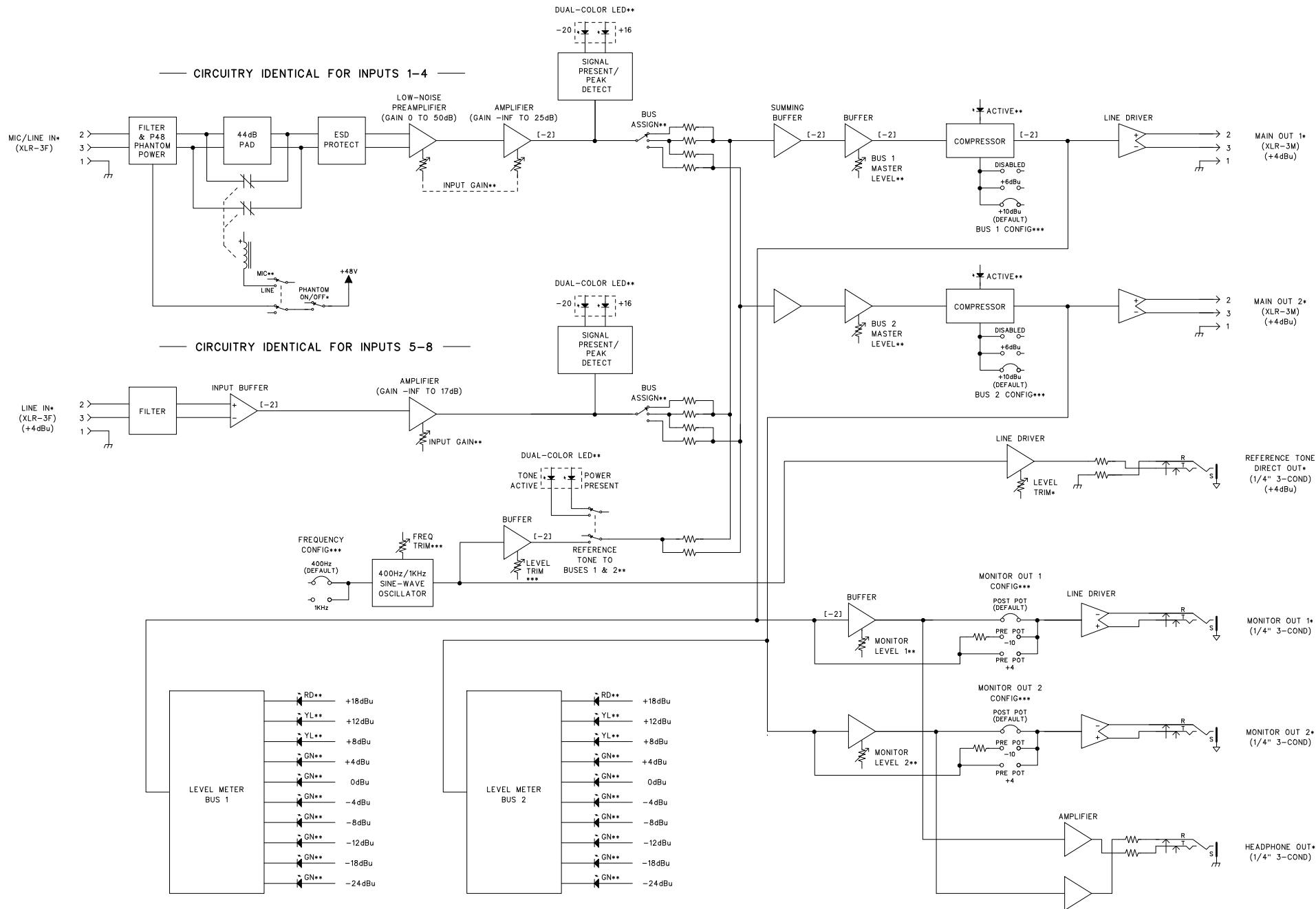

* LOCATED ON BACK PANEL
 ** LOCATED ON FRONT PANEL
 *** LOCATED ON PCB INSIDE ENCLOSURE
 (NOMINAL LEVEL IN dBu)

M742ABD_A

STUDIO TECHNOLOGIES, INC.		
MODEL 742A AUDIO MIXER BLOCK DIAGRAM		
DRAWING NO.	DATE	PAGE
31159	07/30/12	01 OF 01

FOR SN 01151 AND LATER

